

FEBRUARY 1, 2011

BULLETIN

FEC-PMCT-11C



www.ericksonelectric.com

FIRST ENERGY

APPROVED
2500 AMP. TO 4000 AMP.

PAD MOUNTED METERING TRANSFORMER CABINETS



FILE NO. E62784

600 VOLT MAXIMUM
TYPE 3R ENCLOSURE

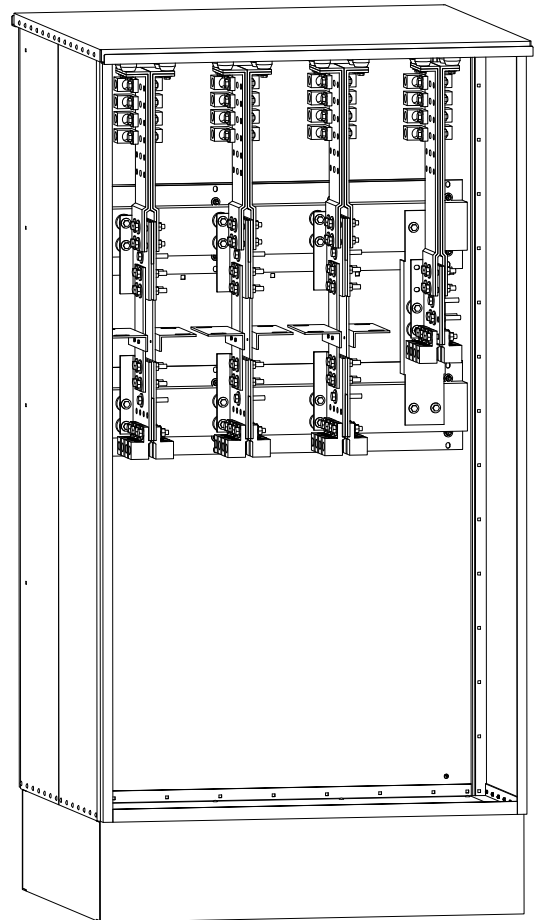

ERICKSON ELECTRICAL EQUIPMENT CO.
475 BONNIE LANE • ELK GROVE VILLAGE, IL 60007
TELEPHONE: (847) 640-7701 / 1-800-952-7225
FAX: (847) 640-0565

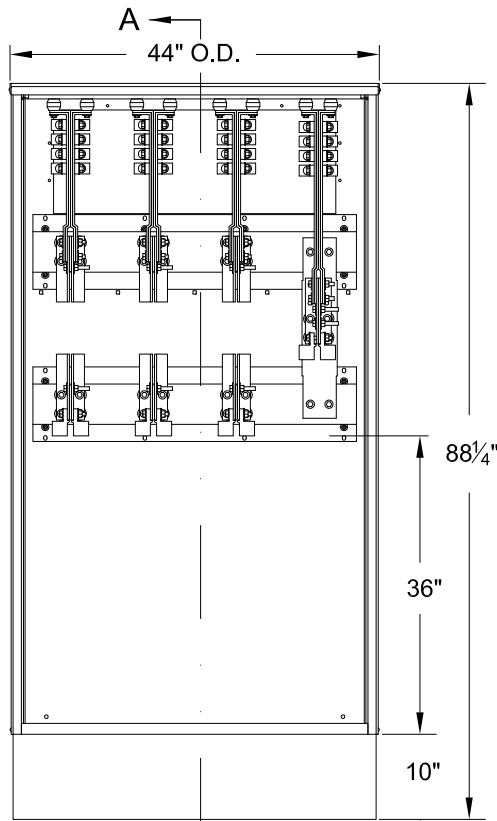

METERING TRANSFORMER
COMPARTMENT
(COVER REMOVED)

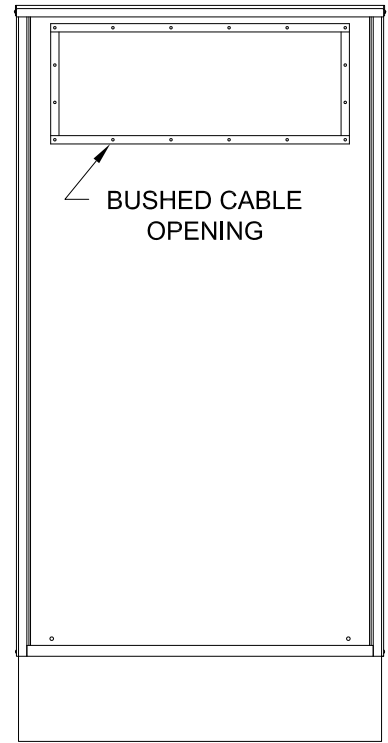

CONDUCTOR
COMPARTMENT
(COVER REMOVED)

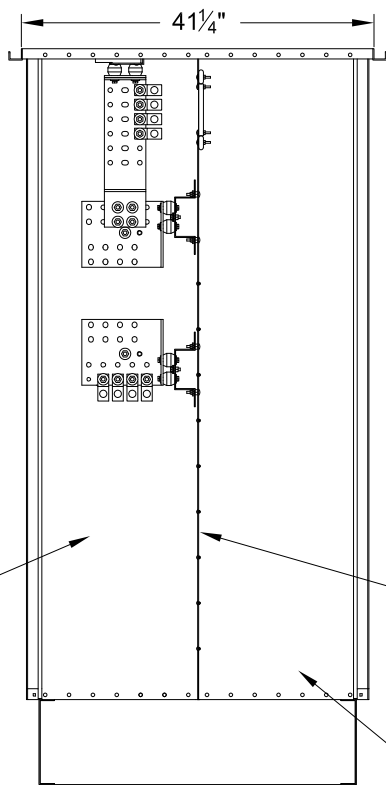

SECTION A - A

ALUMINUM
ENCLOSURE
TYPE 3R

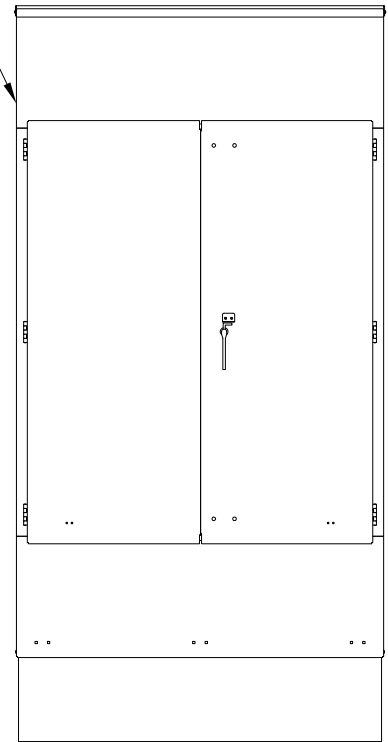

FRONT ENCLOSED VIEW

METERING
TRANSFORMER
COMPARTMENT

COMMON
BACKPLATE

CONDUCTOR
COMPARTMENT

ERICKSON ELECTRICAL EQUIPMENT CO.
475 BONNIE LANE • ELK GROVE VILLAGE, IL 60007
TELEPHONE: (847) 640-7701 / 1-800-952-7225
FAX: (847) 640-0565

CATALOG NUMBERS

AMPACITY	3Ø 4W	LUGS PER PHASE 300-600 KCM		UNPROTECTED FAULT CURRENT RATING	ENCLOSURE SIZE			SHIPPING WEIGHTS
		LINE	LOAD		WIDTH	HEIGHT	DEPTH	
2500	PMCT254-FECD	7	7	100,000 Amp	44"	88"	42"	750 LBS.
3000	PMCT304-FECD	8	8	100,000 Amp	44"	88"	42"	800 LBS.
4000	PMCT404-FECD	10	10	100,000 Amp	44"	88"	42"	825 LBS.

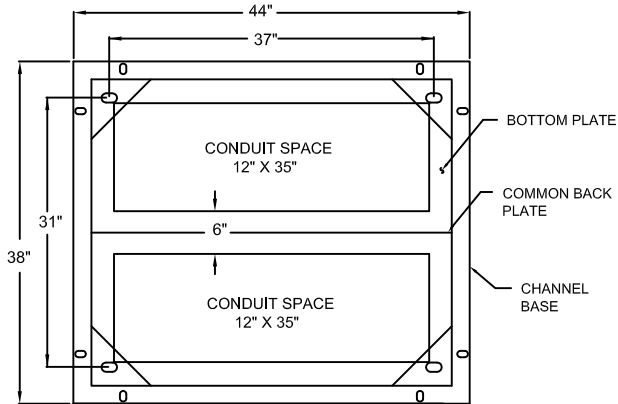
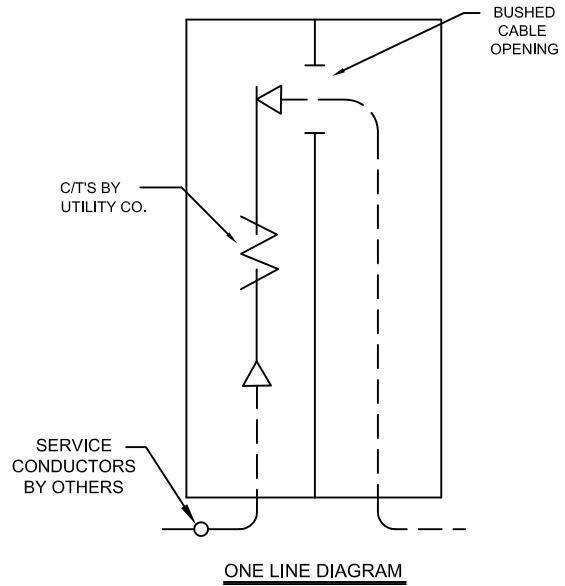
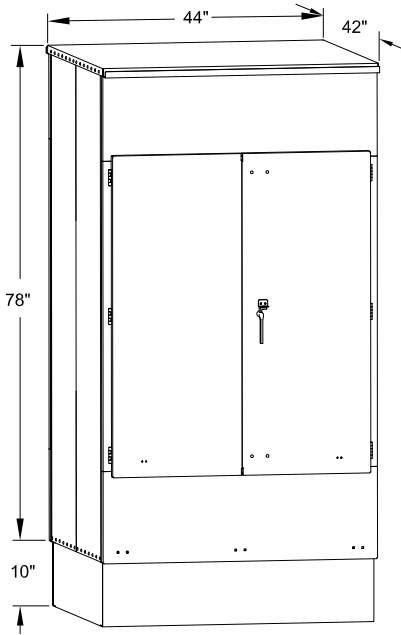

BOTTOM VIEW

(SHOWING AVAILABLE CONDUIT SPACE)

REMOVABLE COVERS OVER CONDUCTOR COMPARTMENT

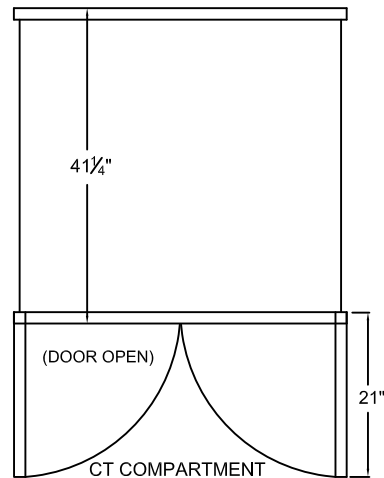

TOP VIEW

REPRESENTED IN
OHIO & PENNSYLVANIA
BY

ROSATI SALES

815 E. TALLMADGE AVE • AKRON, OH 44310
TELEPHONE: (330) 630-2677 FAX: (330) 633-3645

ERICKSON ELECTRICAL EQUIPMENT CO.

475 BONNIE LANE • ELK GROVE VILLAGE, IL 60007
TELEPHONE: (847) 640-7701 / 1-800-952-7225
FAX: (847) 640-0565